

SEL SERIES 4-HOUR RUN TIME STEEL EMERGENCY LIGHT



4-HOUR RUN TIME

This model is configured for an 4-hour run time with (2) 7.2W lamp heads. Combining a 6V 54W capacity battery pack with a 14.4-watts total lamp consumption yields a 240-minute run time.

OVERVIEW

The SEL Series heavy-duty emergency lights feature a rugged 20-gauge steel housing finished in a white powder coat. The SEL features (2) top-mounted 7.2W lamps with housings constructed from high impact thermoplastic in a matching white finish.

The SEL Series is popular for a variety of applications; this heavy-duty fixture is ideal for many commercial environments including schools, warehouses, apartment buildings, and government institutions.

The SEL surface mounts in a number of different ways to a variety of surfaces and features conduit knockouts on either side of the unit making installation simple.

EXTERNAL SPECIFICATIONS

The 20-gauge steel enclosure with white powder coat finish provides a secure environment for the battery and circuitry of the unit while the lamp heads are mounted securely to the top of the fixture.

The SEL allows for remote lamp heads to be connected to the unit and utilizes the unit's battery backup system. Sturdy magnum terminal connectors enable large gauge wire to be utilized, which increase the flexibility of installation. The 4-hour run time is reduced as each additional lamp head is connected.

INTERNAL SPECIFICATIONS

The SEL is configured with universal 120/277V AC input and solid state charging circuitry. Low voltage disconnect, AC lockout, and brownout protection are included standard.

LAMP SPECIFICATIONS

7.2-watt, HIT wedge-base lamps are standard. Comes with (2) lamp heads but can also be ordered with one; or no lamps at all. When ordered with no lamps the unit is essentially a recessed power supply for remotely located lamp fixtures.

LAMP DETAILS

- 6-Volt 7.2-Watt
- 3500K Color Temp
- High Intensity Tungsten

DIMENSIONS

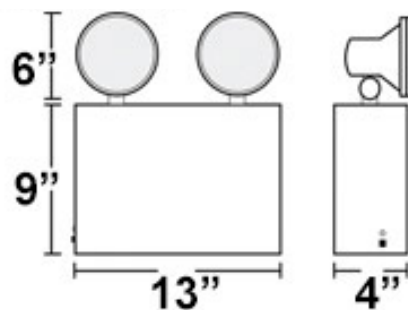

BATTERY

This emergency light is outfitted with a maintenance free, sealed valve regulated lead calcium battery. The battery features a 24 to 48-hour recharge time and provides 240-minutes of emergency run time for the standard model with 7.2W HIT lamp heads. Comes standard with a current charge regulator.

The SEL Series begins features a sealed lead acid battery. Nickel cadmium batteries are available as an option for the unit and increases the battery life as well as the cost. We carry a full line of reliable replacement batteries.

AUTO-TEST

Choose the Auto-Test (AT) option to eliminate monthly testing requirements. The self-diagnostic system constantly monitors all aspects of the unit including battery, circuit board, and transformer.

WARRANTY

The SEL Series comes with a 3-year factory warranty. The lamps are not covered. Deliberate damage, misuse, or improper installation effectively cancel the warranty. Battery features a 20% per year pro-rata warranty.

CODE COMPLIANCE

The SEL Series emergency light is compliant with building and fire code regulations throughout the United States and Canada. CSA US Listed to UL 924. NFPA 101 Life Safety Code, NEC, ICC, IBC, Damp Location Approved.

INSTALLATION

Steel emergency lights are for indoor installation onto normally inflammable surfaces. They are designed for heavy-duty applications that do not feature direct contact with moisture or corrosive agents.

The SEL Series is suitable for wall mounting and features side and back conduit knockouts. The unit comes with detailed instructions for installation. Connect either 120 or 277V AC power into the unit, connect the battery, and let the fixture charge for 24 hours.



ORDERING INFORMATION

Series	Operation	Capacity	Heads	Lamp Type	Options
SEL	6 (volt DC)	54 (54 watt)	2 (double)	7.2W (7.2-watt)	AT (auto-test)